

Technical Data Sheet

WEISS™

FV107

ClearFlow Inline

150mm ducting

Dimensions

Cut-out size for inlet fascia 155mm

Cut out size for outlet vent 155mm

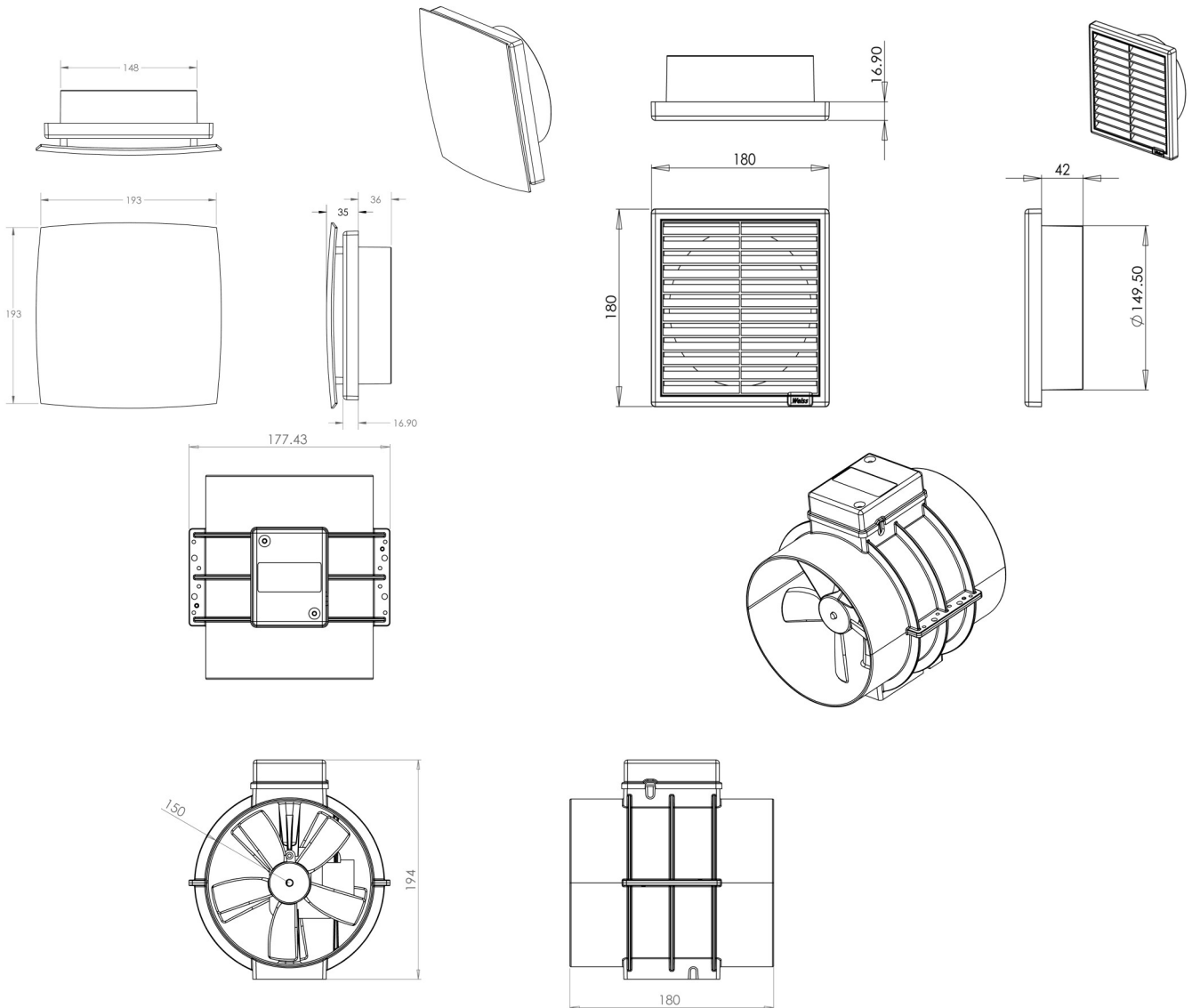

Specifications

Weight	2kg
Colour of front fascia	White
Housing material	ABS

Approval

AS/NZS 60335.2.80:2004 Amdt 1
AS/NZS 60335.1.2011 incl Amdt.1

Features

- Easy to install
- 3 metres of 150mm ducting supplied
- Quiet powerful fan motor
- Allows moisture to be removed to the outside of your home
- All parts are included
- 3 year extended warranty

Technical Data Sheet

Product Use

The FV107 is used for the extraction of mist and steam

Typical applications:

- Bathrooms
- Toilets
- Laundries

Environmental Conditions

Operation	to IEC 721-3-3
Climatic conditions	class 3K5
Temperature	0...+50°C
Humidity	<95% r.h.

Standards

Test standards	AS/NZS 603350.2.80: 2004 Amdts 1 and 1:2011 Amdt.1 5773
Test Report no EMC Compliance	This is a Level One product with an C frame motor that has a very low risk of causing EMC Interference

General

Free Air Fan Performance	420m ³ / hr 116.0L/sec
Installed decibel rating	45DB

Ordering

When ordering please give name and type,	
Reference	FV107
Barcode	9420004902574

Technical Data

Power Supply	230 VAC
Power consumption	max. 0.4 Amps
Supply Line fusing	max. 10A
For solid wires	2 x 1.5mm ²
Motor	230-240VAC 50Hz 0.4 Amp
Motor insulation class	B1
Total motor wattage	40 Watts
Motor protection	Thermally protected
Total product wattage	40 watts